

Erkend Organisme
 O.C.B.
 Koningin Astridlaan 60
 2550 Kontich
 Tel.: 03 451 37 00
 Fax: 03 451 37 10
 e-mail: dep.ele@ocb.be

Handwritten notes:
 532106h
 71210

Plaats van de elektrische installatie
 Kuurnsestraat 164
 8531 Harelbeke/Bavikhove

Installateur
 Oost Electrics
 Smissestraat 48
 8880 Sint-Eloois-Winkel
 GSM: 0479/26.10.32
 BE0663.800.197



p. 1/5
Eendraadschema
 2 x 230V ~ 50Hz

Stopc. wasmeubel
+ slaapkamer
ouder

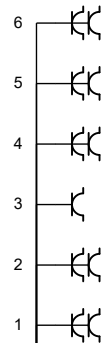

2P - 20A
VOB 3G2,5

Verwarming
badkamer

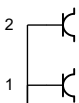

2P - 20A
VOB 3G2,5

Warmtepomp



2P - 20A
VOB 3G2,5

Domeelpomp



2P - 20A
VOB 3G2,5

Verlichting
geleijkvloers

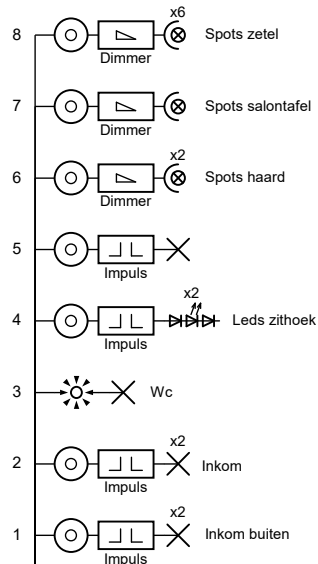

2P - 16A
VOB 3G1,5

Verlichting
geleijkvloers 2

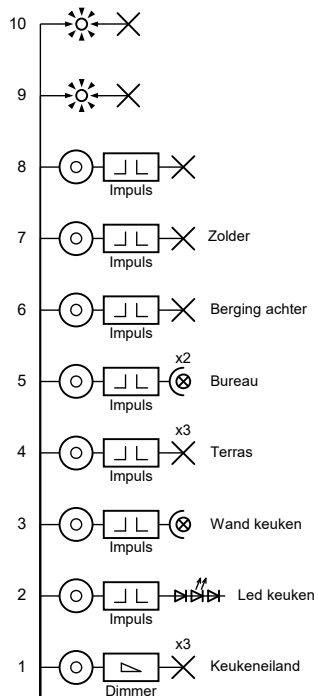

2P - 16A
VOB 3G1,5

Verlichting
verdieping

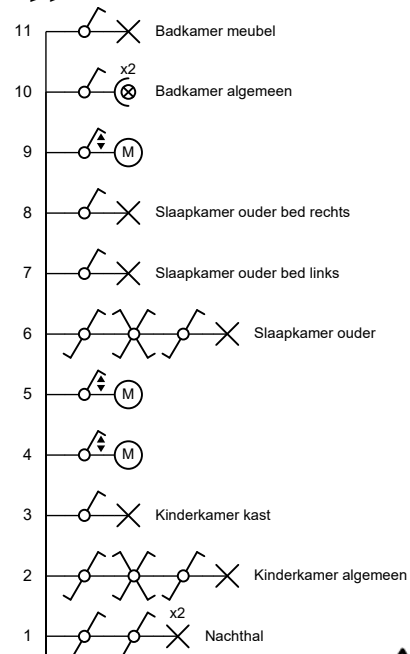

2P - 16A
VOB 3G1,5

MW
7/2/20

Erkend Organisme

O.C.B.
Koningin Astridlaan 60
2550 Kontich
Tel.: 03 451 37 00
Fax: 03 451 37 10
e-mail: dep.ele@ocb.be

Plaats van de elektrische installatie

Kuurnsestraat 164
8531 Harelbeke/Bavikhove

Installateur

Oost Electrics
Smissestraat 48
8880 Sint-Eloois-Winkel
GSM: 0479/26.10.32
BE0663.800.197



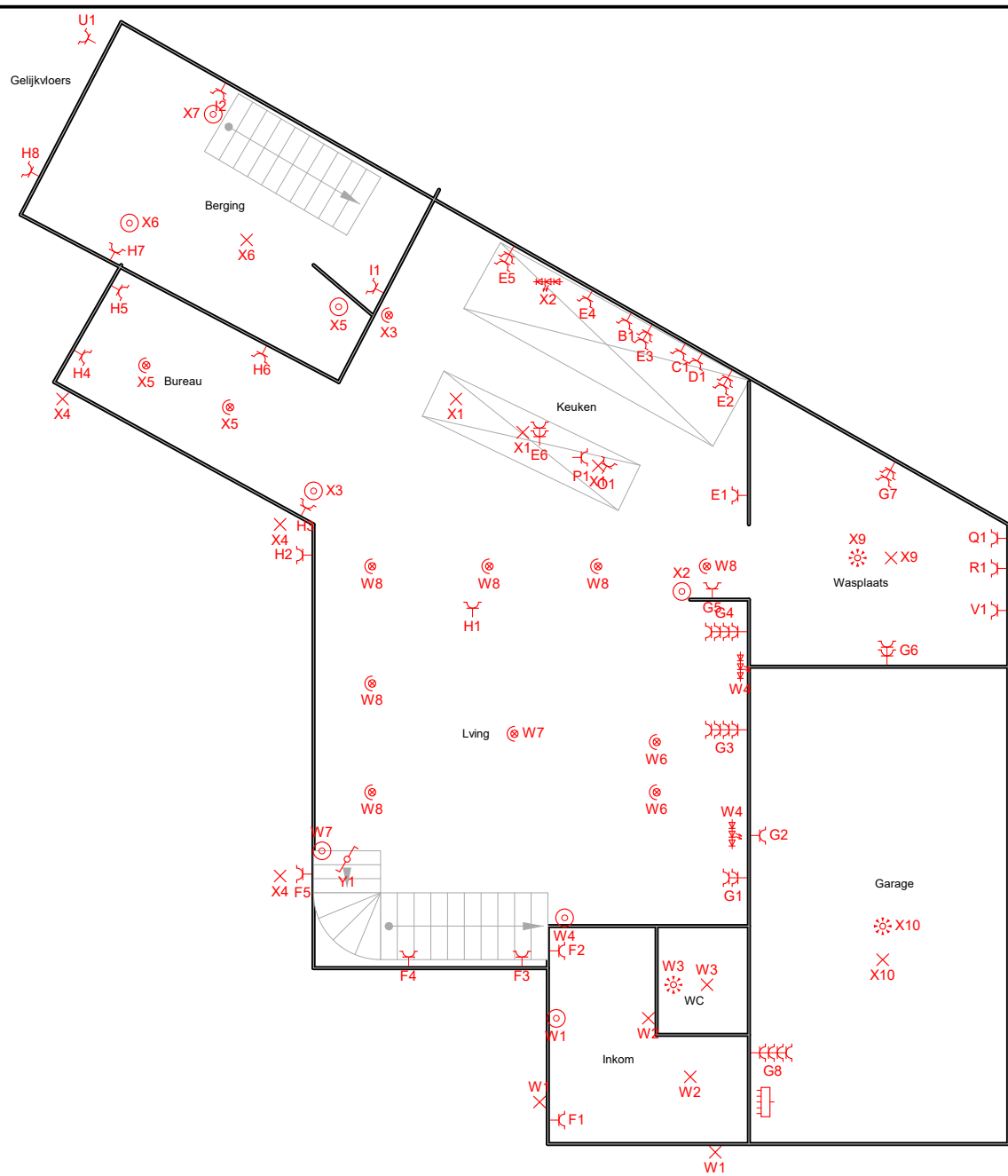

Erkend Organisme

O.C.B.
 Koningin Astridlaan 60
 2550 Kontich
 Tel.: 03 451 37 00
 Fax: 03 451 37 10
 e-mail: dep.ele@ocb.be

Plaats van de elektrische installatie

Kuurnsestraat 164
 8531 Harelbeke/Bavikhove

Installateur

Oost Electrics
 Smissestraat 48
 8880 Sint-Eloois-Winkel
 GSM: 0479/26.10.32
 BE0663.800.197



1e Verdieping

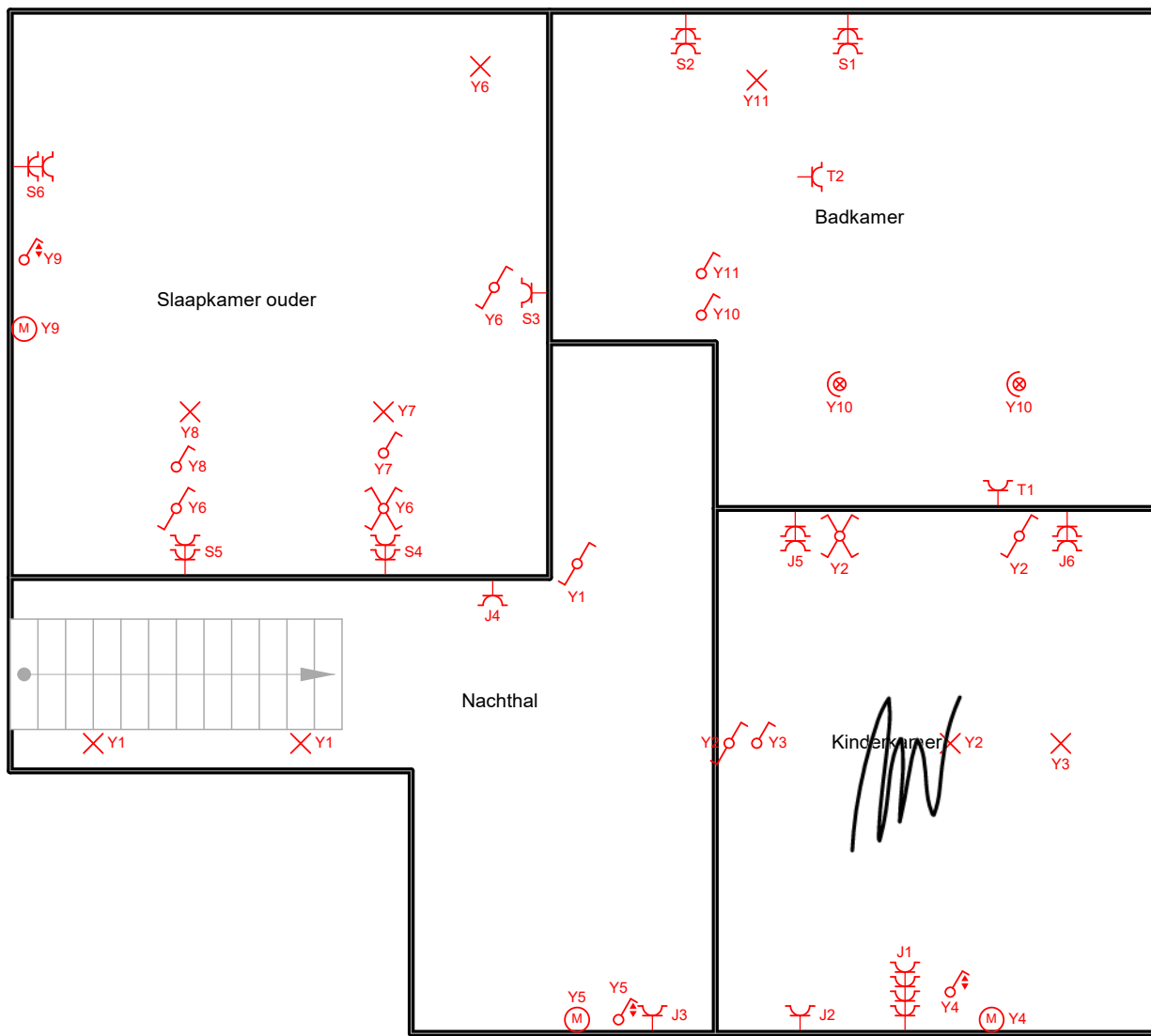
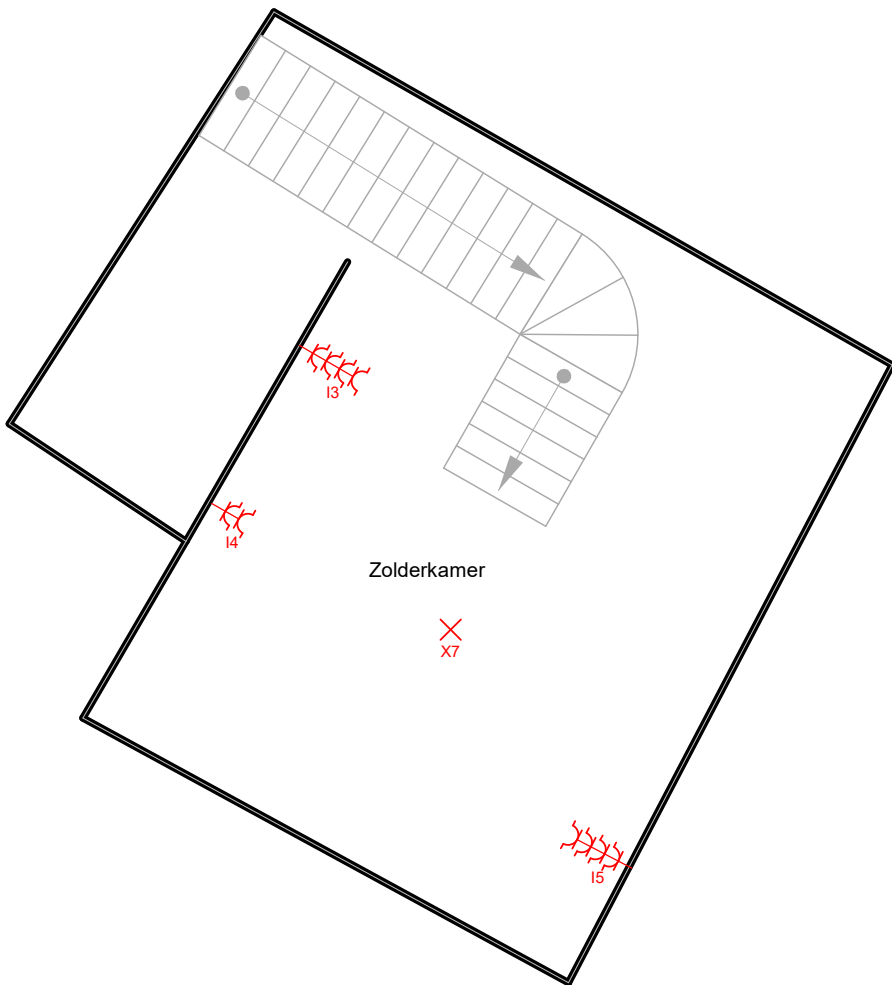

Erkend Organisme

O.C.B.
Koningin Astridlaan 60
2550 Kontich
Tel.: 03 451 37 00
Fax: 03 451 37 10
e-mail: dep.ele@ocb.be

Plaats van de elektrische installatie

Kuurnsestraat 164
8531 Harelbeke/Bavikhove

Installateur

Oost Electrics
Smissestraat 48
8880 Sint-Eloois-Winkel
GSM: 0479/26.10.32
BE0663.800.197



**p. 4/5
Situatieschema**

2 x 230V ~ 50Hz

- A** Hoofddifferentieel
- B** Kookplaat
- C** Oven
- D** Microgolf
- E** Stopc keuken
- F** Stopc inkom + zithoek trap
- G** Stopc zithoek tv muur/ berging /telenet
- H** Stopc bureau/berging achter
- I** Stopc zolderkamer
- J** Stopc kinderkamer
- K** Stopc
- L** Ventilatie
- M** Zonnepanelen
- N** Bijkomende differentieel
- O** Vaatwas
- P** Boiler
- Q** Wasmachine
- R** Droogkast
- S** Stopc wasmeubel + slaapkamer ouder
- T** Verwarming badkamer
- U** Warmtepomp
- V** Dompelpomp

- W** Verlichting gelijkvloers
- X** Verlichting gelijkvloers 2
- Y** Verlichting verdieping



Erkend Organisme
 O.C.B.
 Koningin Astridlaan 60
 2550 Kontich
 Tel.: 03 451 37 00
 Fax: 03 451 37 10
 e-mail: dep.ele@ocb.be

Plaats van de elektrische installatie
 ██████████
 Kuurnsestraat 164
 8531 Harelbeke/Bavikhove

Installateur
 Oost Electrics
 Smissestraat 48
 8880 Sint-Eloois-Winkel
 GSM: 0479/26.10.32
 BE0663.800.197



p. 5/5
Lijst Kringen
 2 x 230V ~ 50Hz